

Construction is made from glued wood, galvanized steel and HDPE.

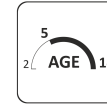

8
children



5 - 14
age

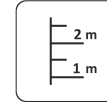

Height of fall
2.015 m

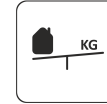

111 kg
(3400x1000x1000 mm)



870 kg



20 h
(without excavation
and concreting)

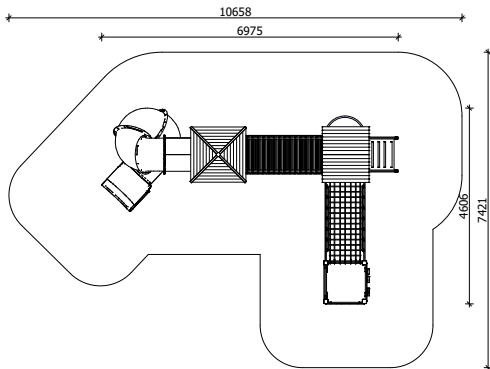

Length: 6 975 mm
 Width: 4 606 mm
 Height: 3 980 mm

Length of safety area: 10 658 mm
 Width of safety area: 7 421 mm
 Required safety area: 56,5 m²

(Install shock absorbing material according to EN1176:2017)

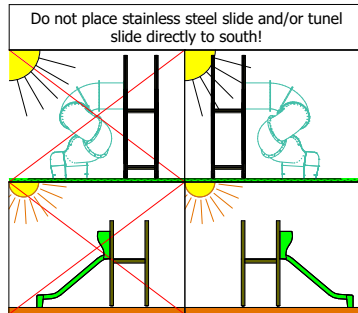

Foundation should be accessible for maintenance

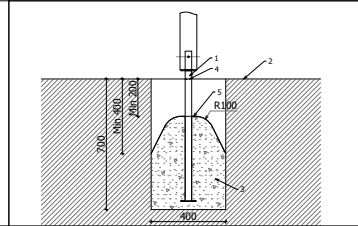

Playground equipment steel foundation is concreted in the ground at the planned location. Foundation should be accessible for maintenance. The equipment can be used after two days when the concrete becomes solid. During assembly no children are allowed in the area.

Equipment safety checkings must be performed once in a week in high vandalism risk areas.

Maintenance is required once in every 3 months, depending on usage

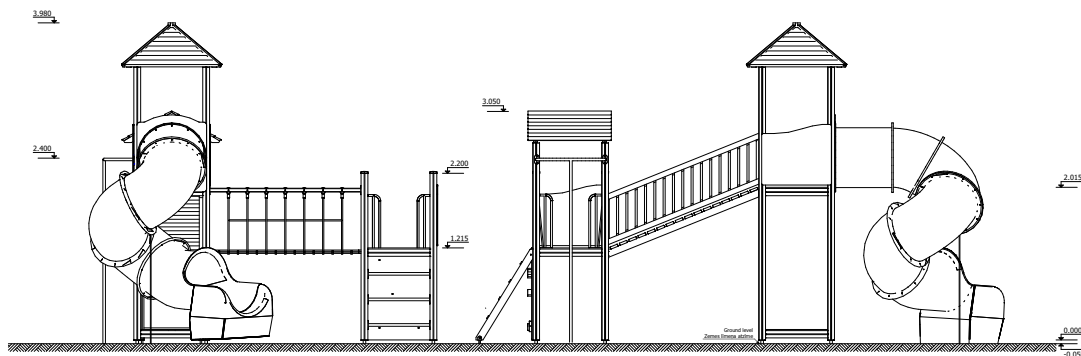

Transportation: Two palettes: 1 palette 2600 x 1000 x 1200 mm - Sliding tube
 1 palette 3400 x 1000 x 600 mm

Spare parts: All needed spare parts and elements, when warranty time expires can be ordered in SIA „Jūrmalas Mežaparki”, and all the goods will be ready for delivery in 3 days.