

Construction is made from glued wood, stainless and galvanized steel metal, rope and HPL laminate.

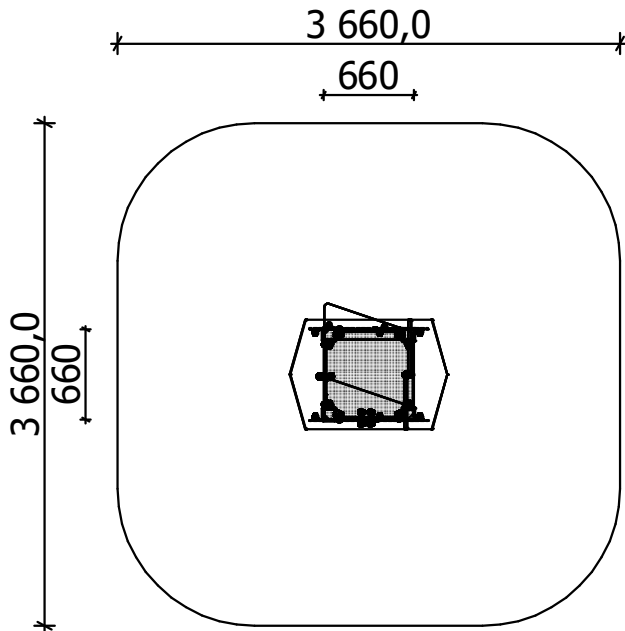

2
children

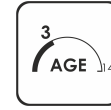

< 3
age

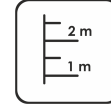

0,10 m
height of fall

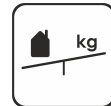

8 kg
(heaviest part)

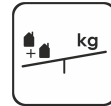

... kg



....
(without excavation and
concreting)

Length: **660 mm**
Width: **660 mm**
Height: **1 685 mm**

Length of safety area: **3 660 mm**
Width of safety area: **3 660 mm**
Required safety area: **12,94 m²**
(Install shock absorbing material according to EN 1176:2017)

Playground equipment steel foundation is concreted in the ground at the planned location. The equipment can be used after two days when the concrete becomes solid. During assembly no children are allowed in the area.

Foundation should be accessible for maintenance.

Equipment safety checkings must be performed once in a week in high vandalism risk area.

Maintenance is required once in every 3 months, depending on usage.

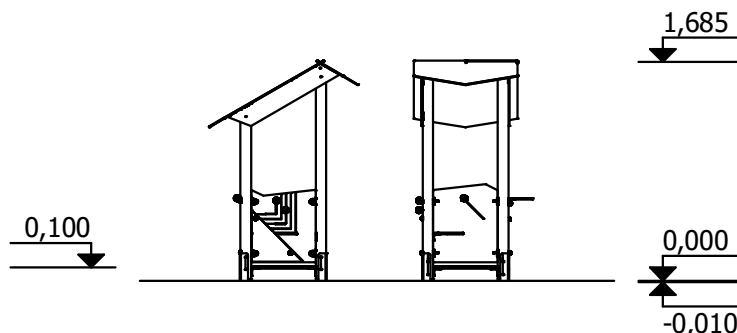
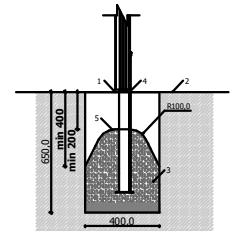

Transportation:

1 (one) palette:
2 000 x 1 000 x 200 mm

Spare parts:

All needed spare parts and elements, when warranty time expires can be ordered in Jūrmalas Mežaparki Ltd., and all the goods will be ready for delivery in 5 working days.

According to EN 1176:2017

Manufactured according:
07.11.2019.



EN 9100
BUREAU VERITAS
Certification

