

Construction is made from glued wood, galvanized steel and HDPE.

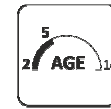

6 children



2 - 5 age

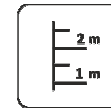

Height of fall
0.400 m



25 kg
(1200x1000x730 mm)



200 kg



3 h
(without excavation
and concreting)

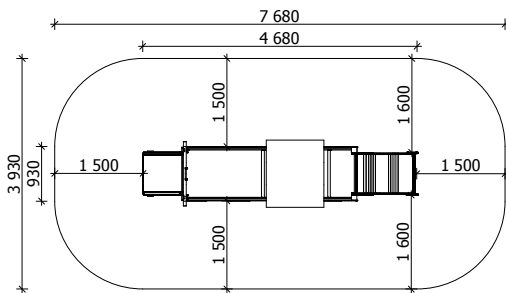
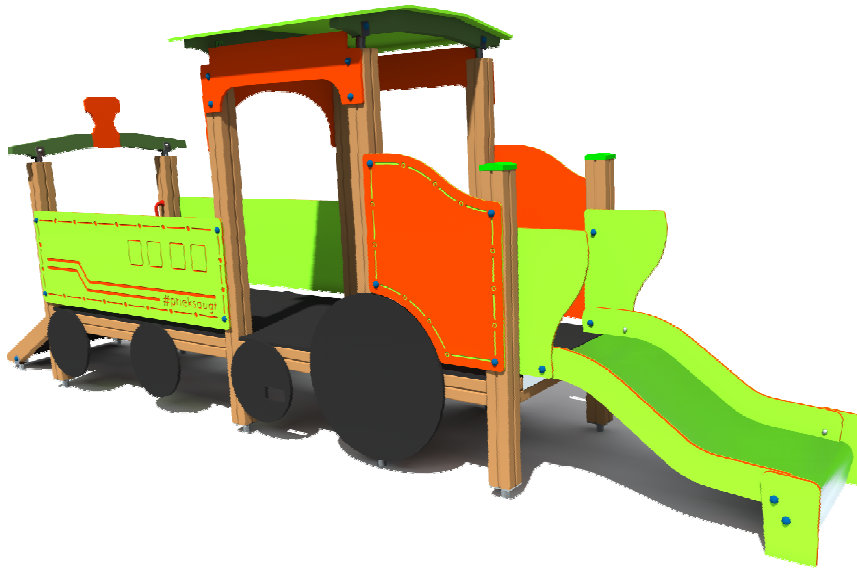

Length: 4 680 mm
Width: 930 mm
Height: 1 770 mm

Length of safety area: 7 680 mm
Width of safety area: 3 930 mm
Required safety area: 28,5 m²

(Install shock absorbing material according to EN1176:2017)

Do not place stainless steel slide and/or tunnel slide directly to south!

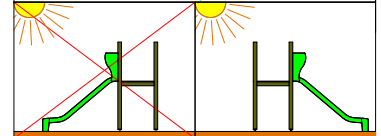

Foundation should be accessible for maintenance

Playground equipment steel foundation is concreted in the ground at the planned location. Foundation should be accessible for maintenance. The equipment can be used after two days when the concrete becomes solid. During assembly no children are allowed in the area.

Equipment safety checkings must be performed once in a week in high vandalism risk areas.

Maintenance is required once in every 3 months, depending on usage

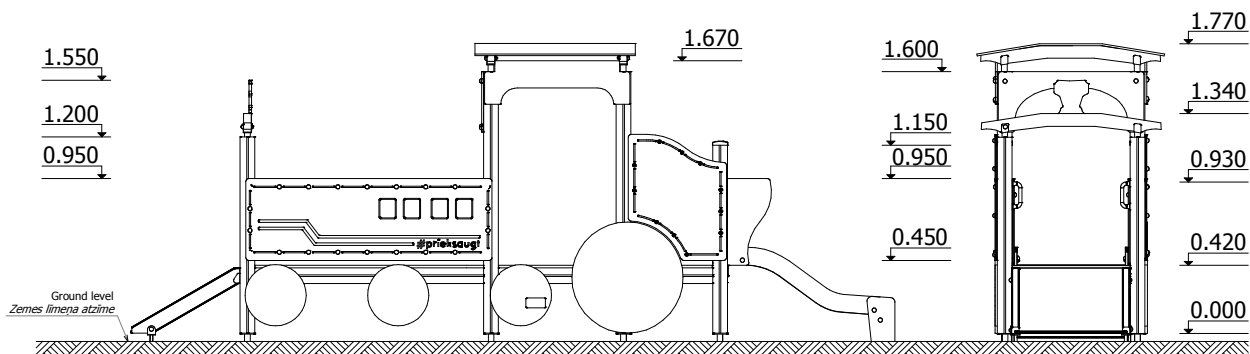
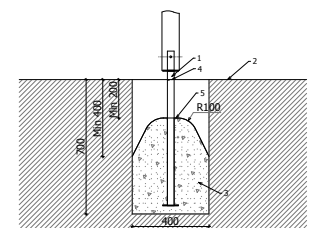

Transportation: One palette: 1 palette 2000 x 1000 x 500 mm

Spare parts: All needed spare parts and elements, when warranty time expires can be ordered in SIA „Jūrmalas Mežaparki”, and all the goods will be ready for delivery in 3 days.