

Construction is made from glued wood, galvanized steel and HDPE.

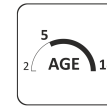

**MAX**  
8 children



**AGE**  
5 - 14 age

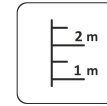

**Height of fall**  
1.80 m

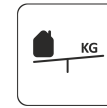

**65 kg**  
(2600x1000x1000 mm)



**354 kg**



**5 h**  
(without excavation and concreting)

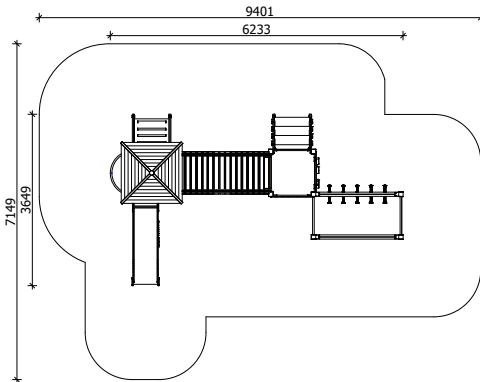

Length: 6 233 mm  
 Width: 3 649 mm  
 Height: 3 180 mm

Length of safety area: 9 401 mm  
 Width of safety area: 7 149 mm  
 Required safety area: 49,5 m<sup>2</sup>  
 (Install shock absorbing material according to EN1176:2017)

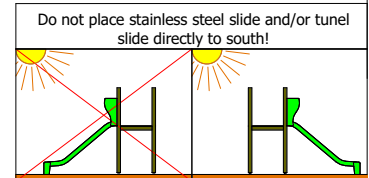

Foundation should be accessible for maintenance

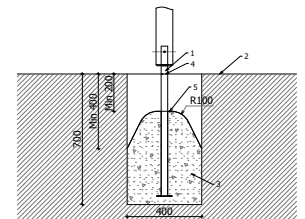

Playground equipment steel foundation is concreted in the ground at the planned location. Foundation should be accessible for maintenance. The equipment can be used after two days when the concrete becomes solid. During assembly no children are allowed in the area.

Equipment safety checkings must be performed once in a week in high vandalism risk areas.

Maintenance is required once in every 3 months, depending on usage

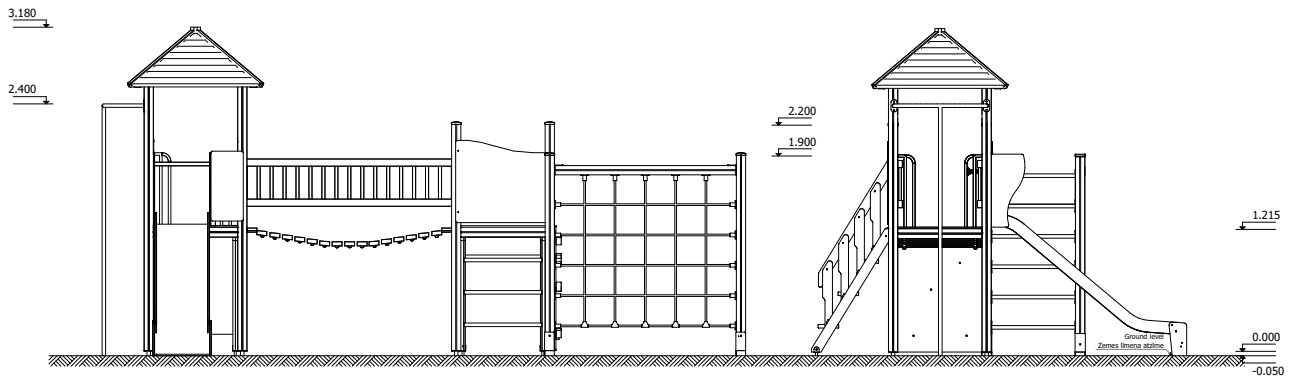

**Transportation:** One palette: 1 palette 2600 x 1000 x 500 mm

**Spare parts:** All needed spare parts and elements, when warranty time expires can be ordered in SIA „Jūrmalas Mežaparki”, and all the goods will be ready for delivery in 3 days.