

HT104

PRODUCT DATA SHEET

Jūrmalas Mežaparki Ltd.

1 Garkalnes street, Jūrmala
+371 299 006 03, www.jmp.lv



Construction is made from glued wood, stainless and galvanized steel metal, plywood and HPL laminate details.

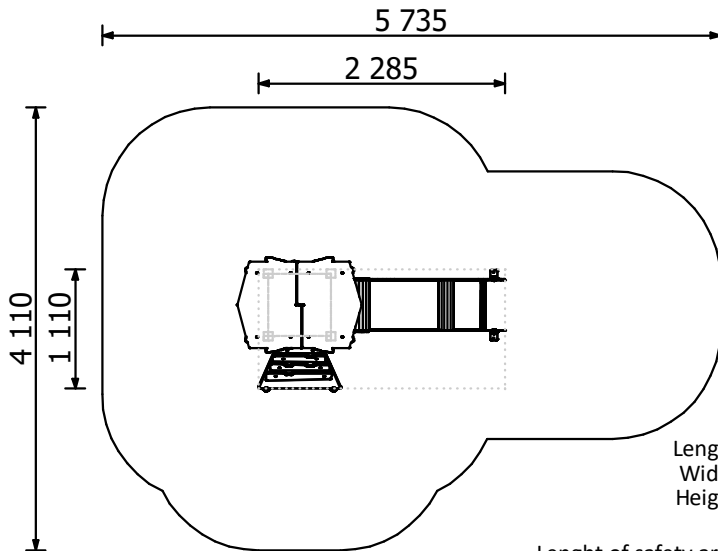

Length: 2 285 mm
Width: 1 110 mm
Height: 2 395 mm /
/ 2 470 mm

Length of safety area: 5 735 mm
Width of safety area: 4 110 mm
Required safety area: 18,17 m²

(Install shock absorbing material according to EN 1176-1)



4
children



< 6
age

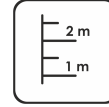

0,80 m
height of fall

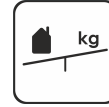

28,43 kg
(heaviest part)

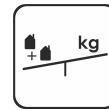

170 kg



3 h
(without excavation and
concreting)

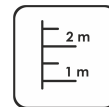

80 x 80 x 2300 mm
overall dimensions
of the largest part

**Do not place stainless steel slide
directly to south!**

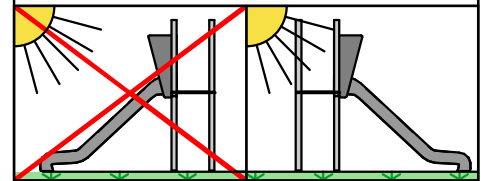

Foundation should be
accessible for maintenance.

Playground equipment steel foundation is concreted in the ground at the planned location. The equipment can be used after two days when the concrete becomes solid. During assembly no children are allowed in the area. Foundation should be accessible for maintenance.

Playground equipment with free height of fall of more than 600 mm and/or equipment causing a force movement on the body of the user, shall be impact attenuating surfacing over the entire impact area.

Equipment safety checkings must be performed once in a week in high vandalism risk area. Maintenance is required once in every 3 months, depending on usage.

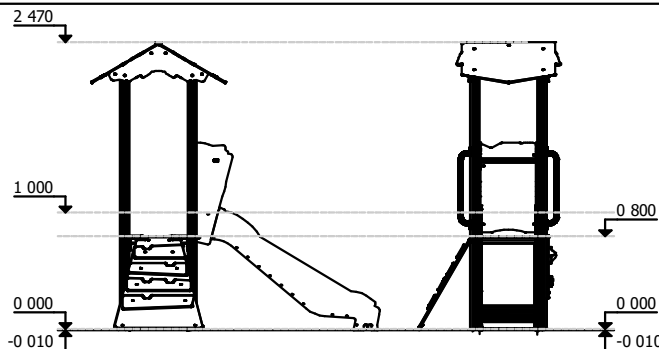
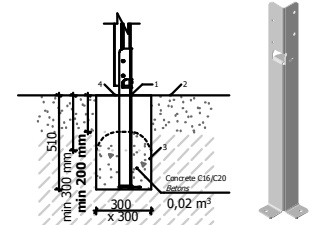

Transportation:

Spare parts:

All needed spare parts and elements, when warranty time expires can be ordered in Jūrmalas Mežaparki Ltd., and all the goods will be ready for delivery in 5 working days.

According to EN 1176-1

Manufactured
according:
07.11.2019.

