

Construction is made from glued wood, galvanized steel and HDPE.

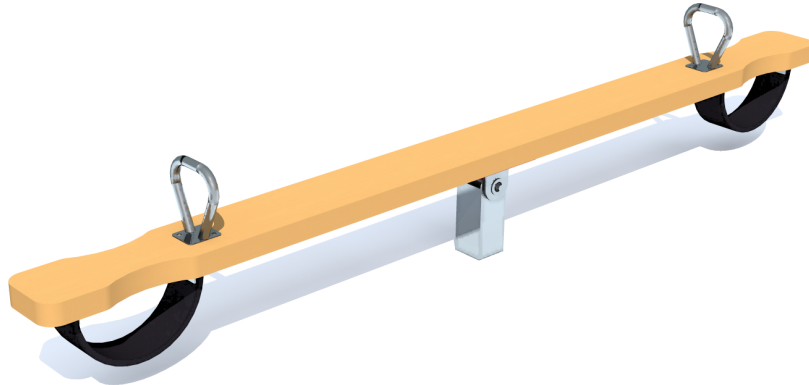

2
children

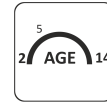

2 - 14
age

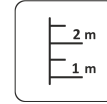

Height of fall
0.63 m

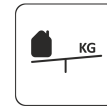

20 kg
(1100x400x140 mm)



143 kg



1,5 h
(without excavation
and concreting)

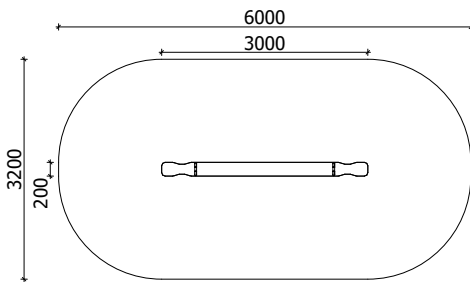

Lenght: 3 000 mm
Width: 200 mm
Height: 400 mm

Lenght of safety area: 6 000 mm
Width of safety area: 3 200 mm
Required safety area: 17,5 m²

(Install shock absorbing material according to EN1176:2017)

Foundation should be accessible for maintenance

Playground equipment steel foundation is concreted in the ground at the planned location. Foundation should be accessible for maintenance. The equipment can be used after two days when the concrete becomes solid. During assembly no children are allowed in the area.

Equipment safety checkings must be performed once in a week in high vandalism risk areas.

Maintainance is required once in every 3 months, depending on usage

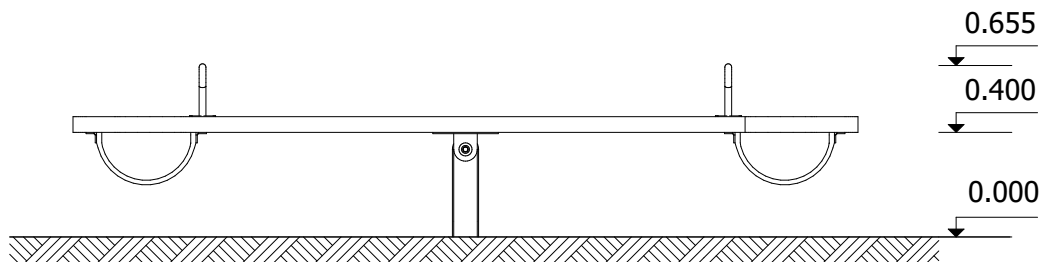
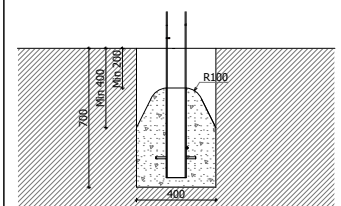

Transportation: One pack: 1 pack 3000 x 500 x 500 mm

Spare parts: All needed spare parts and elements, when warranty time expires can be ordered in SIA „Jūrmalas Mežaparki”, and all the goods will be ready for delivery in 3 days.