

Construction is made from glued wood, galvanized steel metal, rope elements.

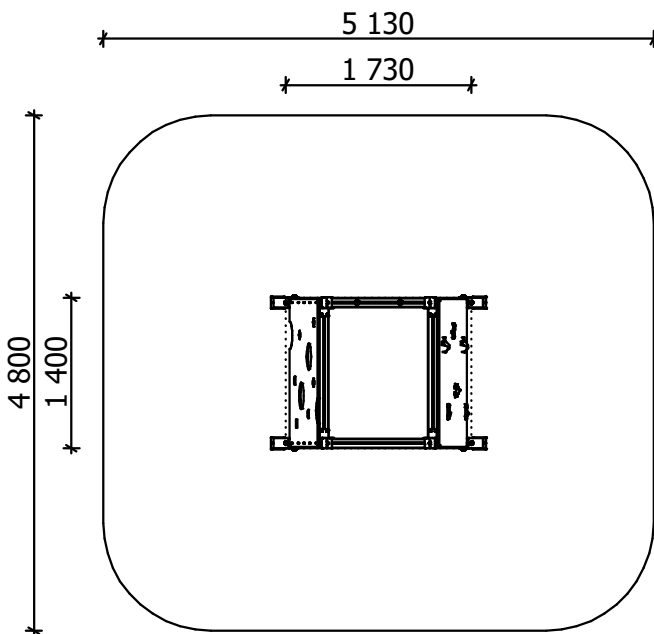

**4**  
children

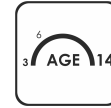

**3 - 14**  
age

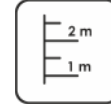

**1,80 m**  
height of fall

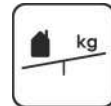

**15 kg**  
(heaviest part)

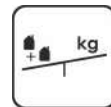

**... kg**



**....**  
(without excavation and concreting)

Length: **1 730 mm**  
Width: **1 400 mm**  
Height: **1 915 mm**

Length of safety area: **5 130 mm**  
Width of safety area: **4 800 mm**  
Required safety area: **23,75 m<sup>2</sup>**  
(Install shock absorbing material according to EN 1176:2017)

Playground equipment steel foundation is concreted in the ground at the planned location. The equipment can be used after two days when the concrete becomes solid. During assembly no children are allowed in the area. Foundation should be accessible for maintenance.

Equipment safety checkings must be performed once in a week in high vandalism risk area.

Maintenance is required once in every 3 months, depending on usage.

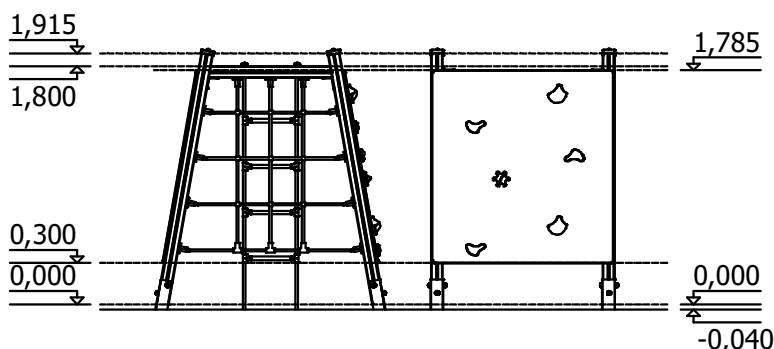
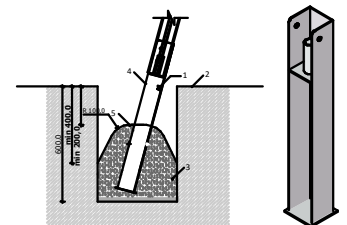

**Transportation:**  
1 (one) palette:  
2 000 x 1 000 x 500 mm

**Spare parts:**  
All needed spare parts and elements, when warranty time expires can be ordered in Jūrmalas Mežaparki Ltd., and all the goods will be ready for delivery in 5 working days.