

Minimum required safety zone - 24.12 m²

Length:	2 130 mm
Width:	1 494 mm
Height:	2 700 mm
Safety Area Length:	6 034 mm
Safety Area Width:	4 895 mm
Safety Area:	24.12 m ²

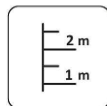

2 users



Critical height of fall
H = 2.45 m

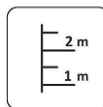

Required user height
from 1.40 m

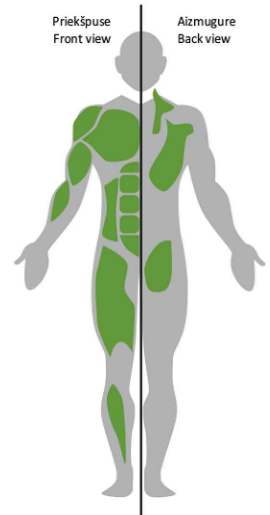
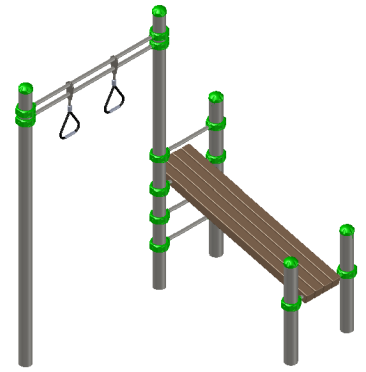

Metal gymnastic complex is intended for public use outdoors.

Gymnastic equipment is established by concreting the steel foundation in planned equipment location. Equipment is suitable for use after two days of concreting when the foundation is totally solid. During assembly no children are allowed in the area. Equipment safety checks must be performed once a week in high vandalism risk areas. Maintenance is required once in every 3 months, depending on usage

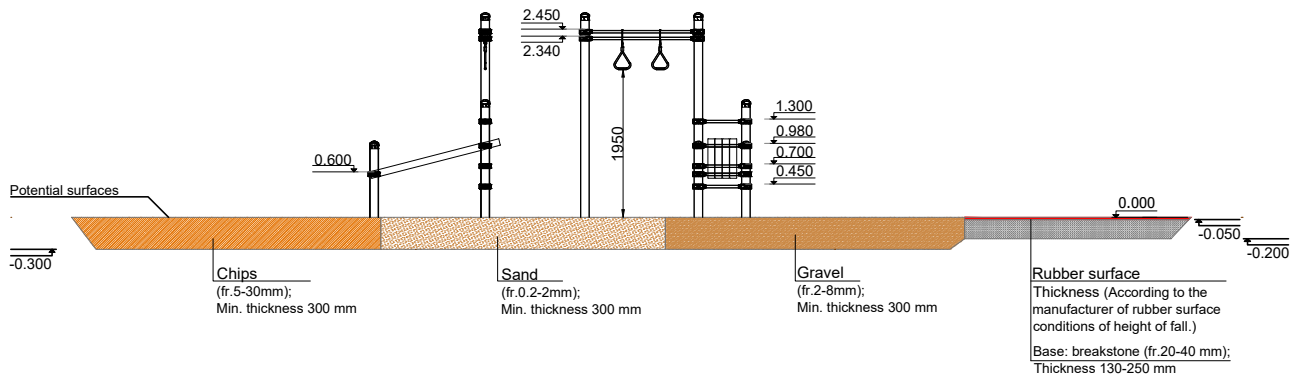
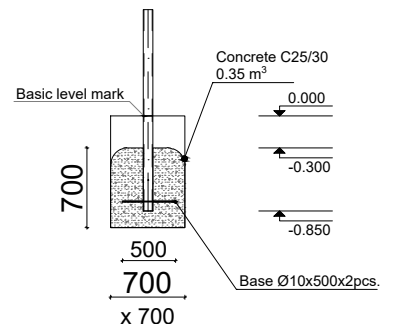

Surface type and its thickness must comply with EN 1177 standard requirements taking into account the fall height of the equipment.