

Minimum required safety zone - 41.27 m²

Length:	4 250 mm
Width:	2 165 mm
Height:	2 700 mm
Safety Area Length:	8 051 mm
Safety Area Width:	6 698 mm
Safety Area:	41.27 m ²

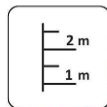

8 users



Critical height of fall
H = 2.35 m

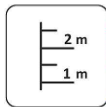

Required user height
from 1.40 m

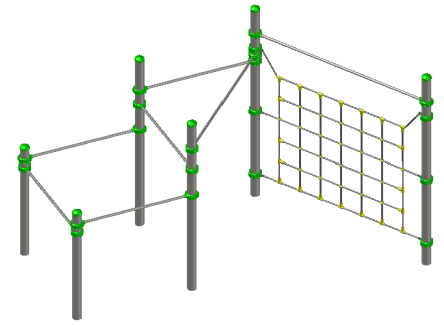

Priekšpuse Front view
Aizmugure Back view

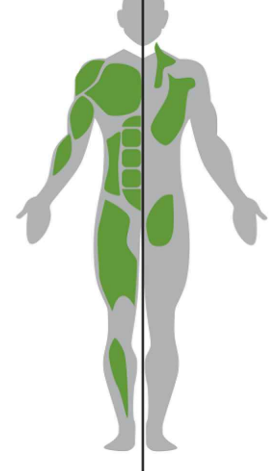

Metal gymnastic complex is intended for public use outdoors.

Gymnastic equipment is established by concreting the steel foundation in planned equipment location. Equipment is suitable for use after two days of concreting when the foundation is totally solid. During assembly no children are allowed in the area. Equipment safety checks must be performed once a week in high vandalism risk areas. Maintenance is required once in every 3 months, depending on usage

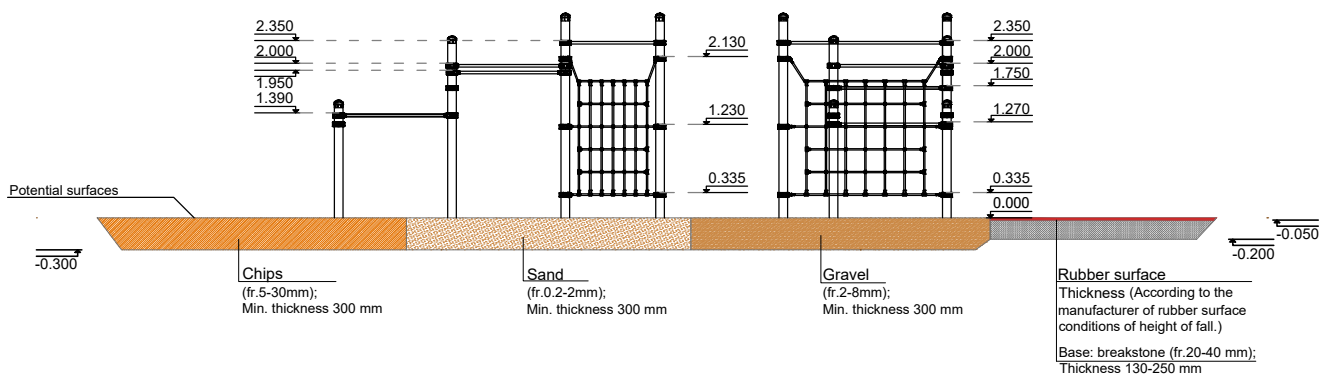
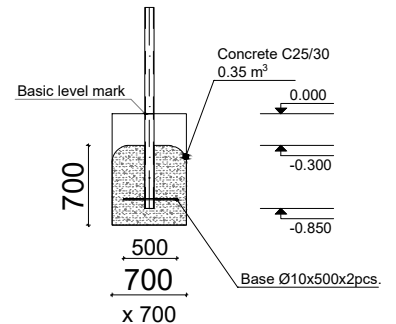

Surface type and its thickness must comply with EN 1177 standard requirements taking into account the fall height of the equipment.