

Minimum required safety zone - 44.32 m²

Length: 2 750 mm
Width: 3 600 mm
Height: 2 700 mm

Safety Area Length: 7 310 mm
Safety Area Width: 7 820 mm
Safety Area: 44.32 m²



3 users

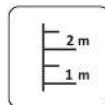

Critical height of fall
H = 2.59 m

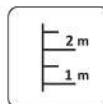

Required user height
from 1.40 m

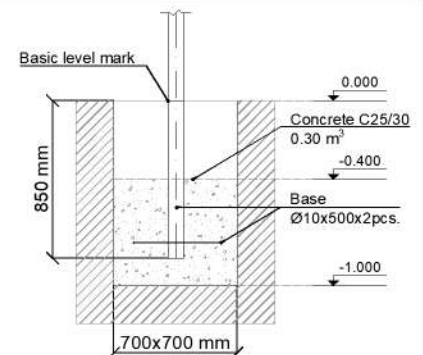
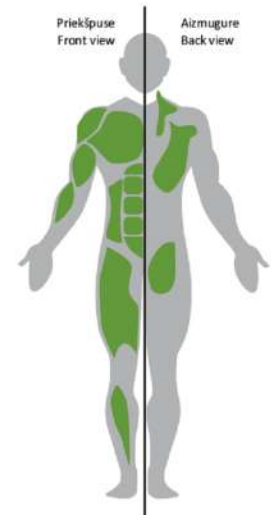
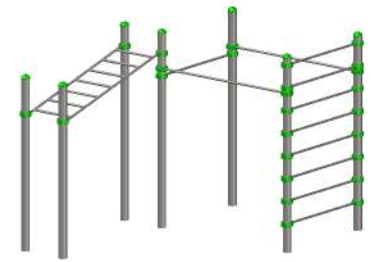

Metal gymnastic complex is intended for public use outdoors.

Gymnastic equipment is established by concreting the steel foundation in planned equipment location. Equipment is suitable for use after two days of concreting when the foundation is totally solid. During assembly no children are allowed in the area. Equipment safety checks must be performed once a week in high vandalism risk areas. Maintenance is required once in every 3 months, depending on usage

