

FIVE245

PRODUCT DATA SHEET

Jūrmalas Mežaparki Ltd.

1 Garkalnes street, Jūrmala
+371 299 006 03, www.jmp.lv



Construction is made from high pressure impregnated wood, stainless and galvanized steel metal, HPL laminate.



5
children

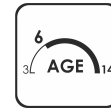

< 14
age

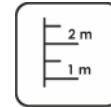

1,20 m
height of fall

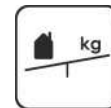

18 kg
(heaviest part)

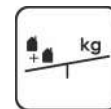

... kg



3 h
(without excavation and concreting)

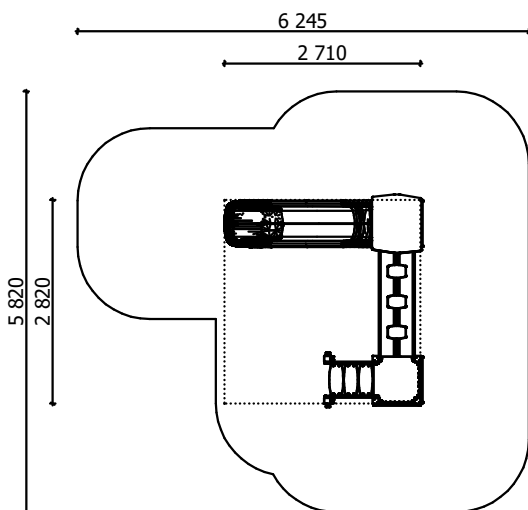

Length: **2 710 mm**
Width: **2 820 mm**
Height: **2 755 mm**

Length of safety area: **5 820 mm**
Width of safety area: **6 245 mm**
Required safety area: **26,87 m²**

(Install shock absorbing material according to EN 1176:2017)

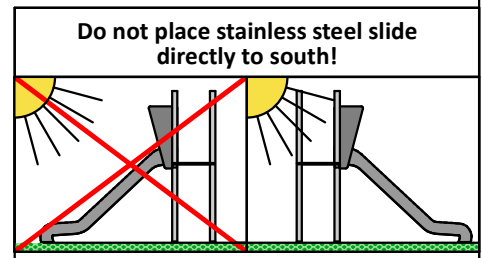

Do not place stainless steel slide directly to south!

Foundation should be accessible for maintenance.

Playground equipment steel foundation is concreted in the ground at the planned location. The equipment can be used after two days when the concrete becomes solid. During assembly no children are allowed in the area.

Equipment safety checkings must be performed once in a week in high vandalism risk area.

Maintenance is required once in every 3 months, depending on usage.

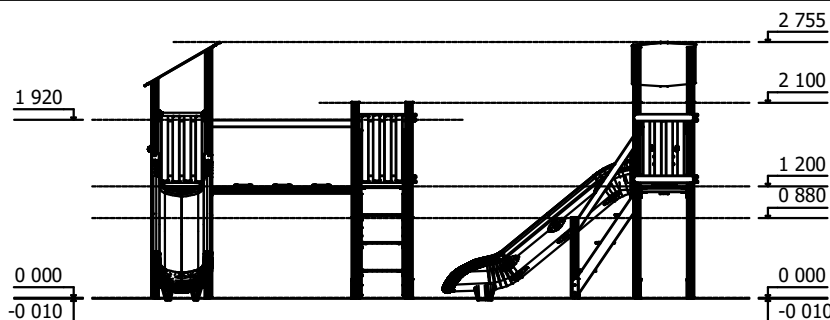
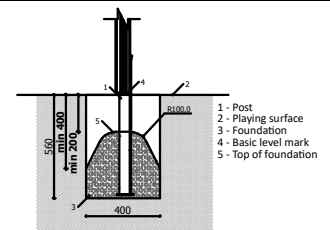

Transportation:

Spare parts:

All needed spare parts and elements, when warranty time expires can be ordered in Jūrmalas Mežaparki Ltd., and all the goods will be ready for delivery in 5 working days.

According to EN 1176-1:2017

Manufactured according:
07.11.2019.

