

Construction is made from glued wood, stainless steel metal, rubber and plastic details.

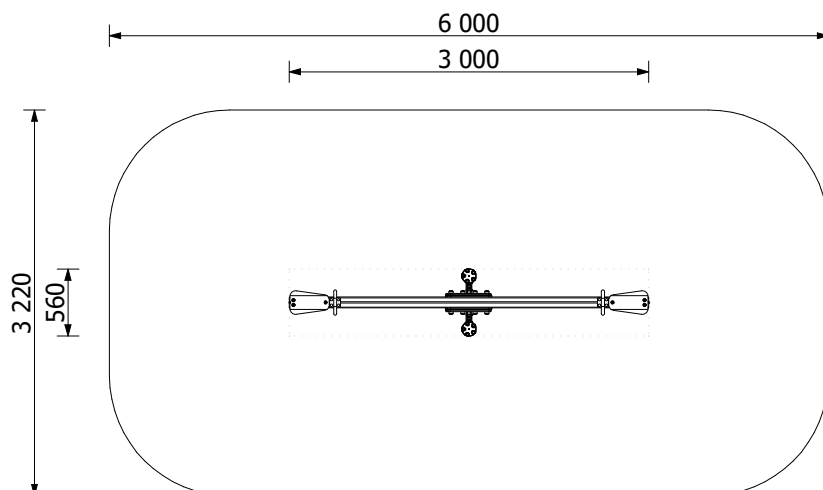

Length: **3 000 mm**
Width: **560 mm**
Height: **565 mm**

Length of safety area: **6 000 mm**
Width of safety area: **3 220 mm**
Required safety area: **18,46 m²**

(Install shock absorbing material according to EN 1176-1)



2
children



>3
age

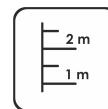

0,865 m
free height of fall

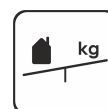

9,30 kg
(heaviest part)

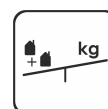

49,90 kg



2 h
(without excavation and concreting)

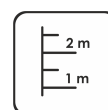

180x3000x90mm
overall dimensions
of the largest part

Available color's palette



In the direction of the swing there must be an extra 500 mm free area of any obstacles!

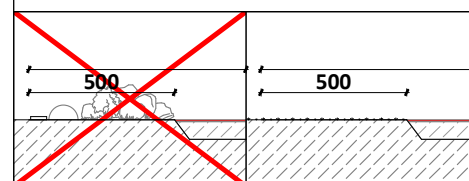

Playground equipment steel foundation is concreted in the ground at the planned location. The equipment can be used after two days when the concrete becomes solid. During assembly no children are allowed in the area. Foundation should be accessible for maintenance.

Playground equipment with free height of fall of more than 600 mm and/or equipment causing a force movement on the body of the user, shall be impact attenuating surfacing over the entire impact area.

Equipment safety checkings must be performed once in a week in high vandalism risk area. Maintenance is required once in every 3 months, depending on usage.

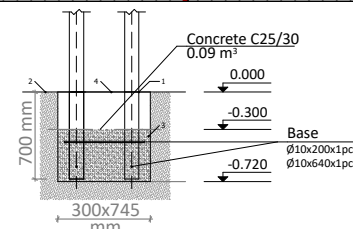

Transportation:

Spare parts:

All needed spare parts and elements, when warranty time expires can be ordered in Jūrmalas Mežaparki Ltd., and all the goods will be ready for delivery in 5 working days.

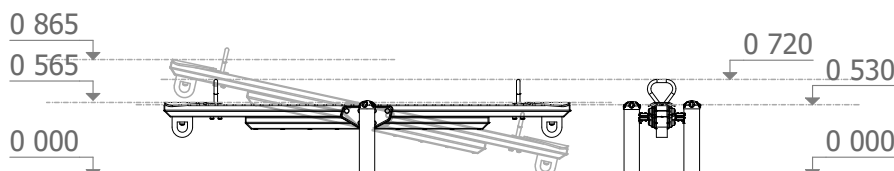

According to EN 1176-1

Manufactured according to 07.11.2019.

