

Construction is made from glued wood, powder coating and galvanized steel metal, HPL laminate details.

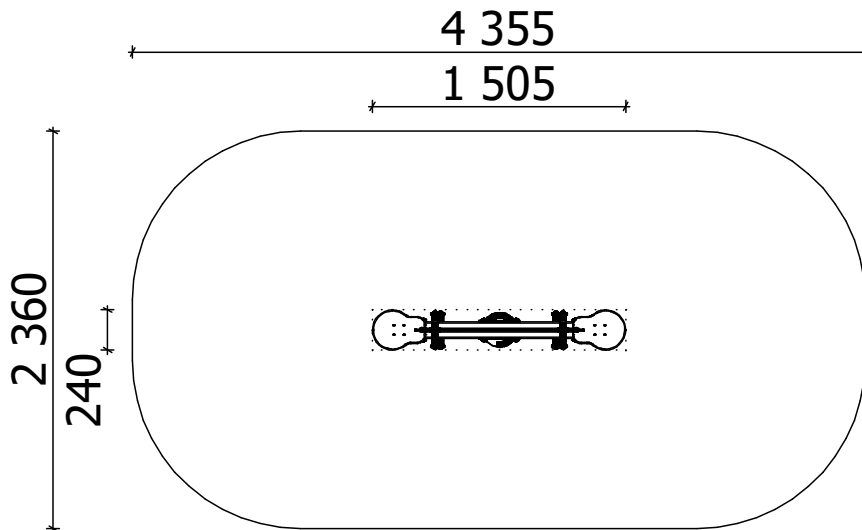

2
children

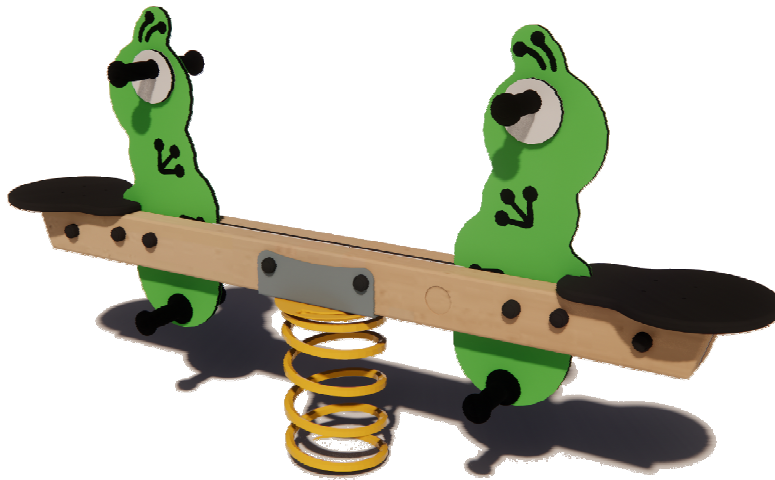

< 6
age

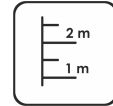

1,00 m **0,52 m**
free height of fall height of fall

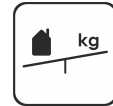

8 kg
(heaviest part)

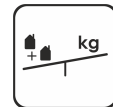

43 kg



1 h
(without excavation and concreting)

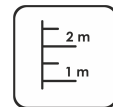

overall dimensions of the largest part

Lenght: **1 355 mm**
Width: **250 mm**
Height: **835 mm**

Lenght of safety area: **4 355 mm**
Width of safety area: **3 100 mm**
Required safety area: **11,60 m²**
(Install shock absorbing material according to EN 1176-1)

Playground equipment steel foundation is concreted in the ground at the planned location. The equipment can be used after two days when the concrete becomes solid. During assembly no children are allowed in the area. Foundation should be accessible for maintenance.

Playground equipment with free height of fall of more than 600 mm and/or equipment causing a force movement on the body of the user, shall be impact attenuating surfacing over the entire impact area.

Equipment safety checkings must be performed once in a week in high vandalism risk area. Maintenance is required once in every 3 months, depending on usage.

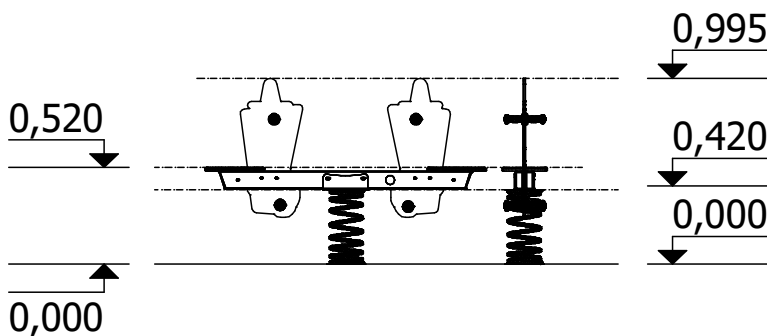
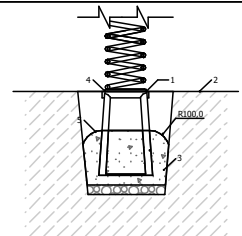

Transportation:

Spare parts:

All needed spare parts and elements, when warranty time expires can be ordered in Jūrmalas Mežaparki Ltd., and all the goods will be ready for delivery in 5 working days.